

## W SERIES

# W2-228

8-INCH FULL-RANGE  
QUASI THREE-WAY LOUDSPEAKER



### APPLICATIONS

#### MAIN PA or DISTRIBUTED

Theme and amusement parks · Water parks  
Outdoor entertainment centers · Cruise ships  
Music pavilions and musical fountains

#### FILL or DELAY

Stadiums · Themed entertainment  
Cruise ships

### DESCRIPTION

As a quasi three-way, full-range loudspeaker system, the W2-228 provides three-way performance in a compact form-factor. It includes 8" LF and 8" MF / LF cones made of carbon fiber. The coaxially-mounted 1" HF driver has a weather-resistant, non-metallic, non-resonant polyimide diaphragm. Drivers are Ferrofluid-cooled to improve heat transfer, resulting in higher power handling and reduced distortion.

The W2-228 is ideal for short throw applications where both full-range reproduction and high weather-resistance are needed, providing an uncompromised musical system in a compact, attractive package.

Engineered for permanent installation, the loudspeaker enclosure and faceplate are constructed of multilayer fiberglass composite, resulting in extreme structural strength. A three-layer Weather-Stop™ grille provides weather-resistance to the internal components, while all exposed hardware is stainless steel or powder-coated aluminum. A weather-resistant stainless steel mounting yoke is included.

An optional "autoformer" version (W2-228T) is available, with a built-in 200-watt autoformer for 70V/100V lines with selectable taps at 200W, 100W, 50W and 25W.

The W2-228 is backed by a five-year product warranty plus a fifteen-year enclosure warranty.

### FEATURES

- All-weather, multilayer fiberglass composite enclosure with stainless steel hardware
- Integral mounting points, included mounting yoke
- High power passive crossover and Ferrofluid-cooled drivers
- Available in black or white finishes
- Powder-coated weather-resistant marine grade aluminum grille and stainless steel yoke
- Available with built-in 200W autoformer for 70V/100V applications

### TECHNICAL SPECIFICATIONS

<b>Loudspeaker Type:</b>	Quasi three-way, full-range
<b>Operating Range:</b>	70 Hz - 18 kHz
<b>Frequency Response:</b>	80 Hz - 15 kHz (±3 dB)
<b>Max Input Ratings (8 ohm):</b>	250W continuous, 500W program
<b>W2-228T Autoformer Taps</b>	
70V:	200W, 100W, 50W, 25W
100V:	200W, 100W, 50W
<b>Sensitivity (1W/1m):</b>	96 dB SPL (100 Hz to 13 kHz 1/3 octave bands) 96 dB SPL (250 Hz to 4 kHz speech range)
<b>Maximum Output:</b>	121 dB SPL / 127 dB SPL (peak)
<b>Nominal Impedance:</b>	4 ohms
<b>Minimum Impedance:</b>	3.2 ohms @ 180 Hz
<b>Nominal Coverage:</b>	85° H x 85° V
<b>Crossover Frequency:</b>	2000 Hz
<b>Drivers:</b>	LF 1 x 8" (203 mm) carbon fiber LF/MF 1 x 8" (203 mm) carbon fiber HF 1 x 1" (25.4 mm) exit, non-metallic diaphragm

### PHYSICAL

<b>Input Connection:</b>	16-2 SJOW (12 ft / 4m) 18-5 SJOW (T-Version)
<b>Enclosure:</b>	Hand-laminated fiberglass
<b>Finish:</b>	Black or white gelcoat
<b>Mounting / Rigging Provisions:</b>	Two (2) 1/2-13 threaded mounting points; yoke included
<b>Grille:</b>	Powder-coated, zinc-plated marine grade aluminum (5052 alloy), black or white finish (three-layer Weather-Stop™)
<b>Environmental:</b>	IP 55W rated per IEC 60529
<b>Dimensions—Height:</b>	10.13 inches (257 mm)
<b>Width:</b>	20 inches (508 mm)
<b>Depth:</b>	11.5 inches (292 mm)
<b>Weight (with yoke):</b>	W2-228 36 lbs ( 16.3kg) W2-228T 40 lbs ( 18.1kg)
<b>Shipping Weight:</b>	W2-228 40 lbs (10.5 kg) W2-228T 46 lbs (20.9 kg)

### OPTIONS

<b>Required Accessories:</b>	Electronic high pass filter (60 Hz, 24dB/octave)
<b>Included Accessory:</b>	Yoke

Recommended signal processing available at [www.communitypro.com](http://www.communitypro.com).

Community strives to improve its products on a continual basis. Specifications are therefore subject to change without notice.

**FREQUENCY RESPONSE**

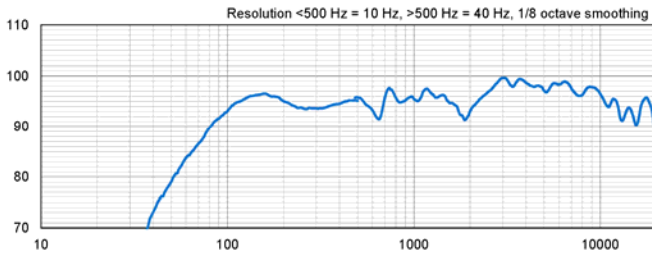

**IMPEDANCE**

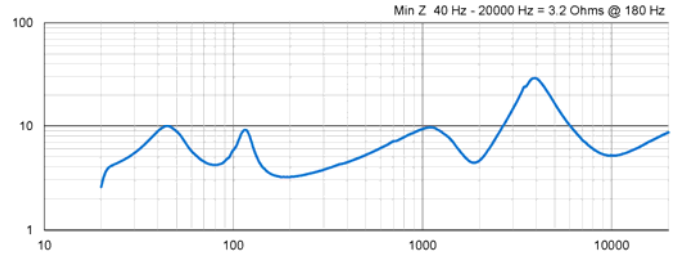

**BEAMWIDTH**

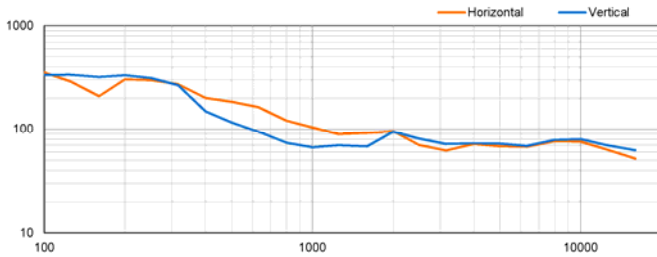

**IMPEDANCE (100W AUTOFORMER)**

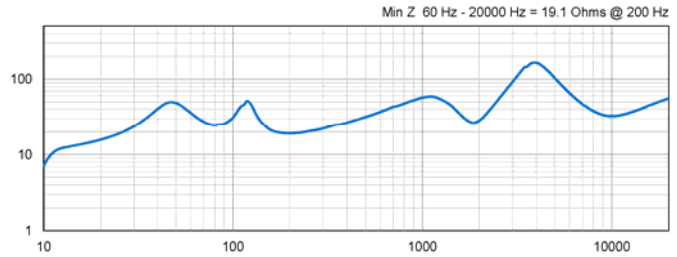

**AXIAL Q**

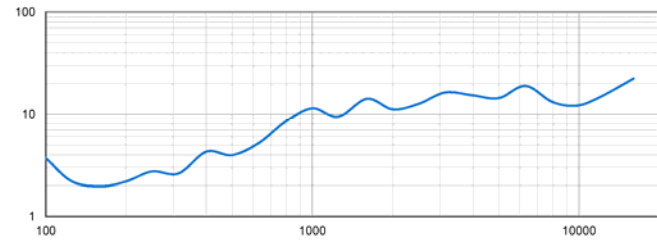

**YOKE**

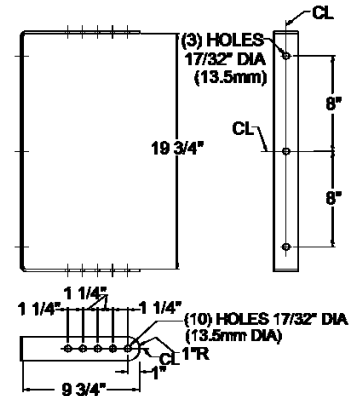

**DIMENSIONS**

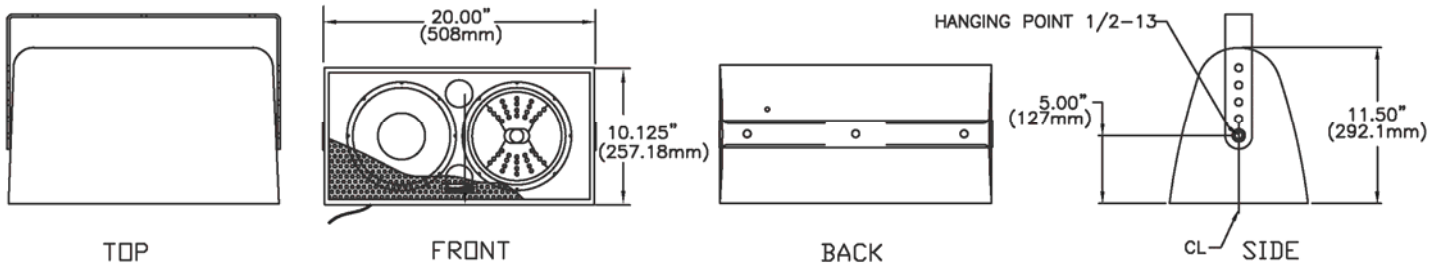

**ARCHITECTURAL SPECIFICATIONS**

The loudspeaker system shall be a full-range, three-way weather-resistant bass reflex design with one 8-inch carbon fiber low frequency woofer, one 8-inch carbon fiber low/mid frequency woofer and one 1-inch exit high frequency driver with a non-metallic diaphragm coaxially mounted on a fiberglass high frequency horn. Drivers shall be connected to an integral crossover with crossover frequency of 2 kHz and integral over-current protection circuitry using high positive current coefficient resistors. The input connection shall be one 12 foot (4m) SJOW #16 gauge cable with stripped ends. The loudspeaker enclosure shall be a molded multilayer fiberglass composite with a powder-coated perforated zinc-plated marine grade aluminum grille backed by weather-resistant material. There shall be two 1/2 - 13 rigging points. The system shall have an amplitude response of 80 Hz - 15 kHz ( $\pm 3$  dB), input capability of 32 volts RMS, 96 dB sensitivity at one meter / 2 V / 4 ohms nominal impedance. The nominal dispersion shall be 85° H x 85° V from 2 kHz - 12.5 kHz. The loudspeaker shall be 10.13 in. (257 mm) high x 20 in. (508 mm) wide x 11.5 in. (292 mm) deep and weigh 36 lbs (16.3 kg).